

1A Positive Voltage Regulator

Features

- Output Current up to 1A
- Fixed output voltage of 5V, 6V, 8V, 9V, 10V, 12V, 15V, 18V and 24V available
- Thermal overload shutdown protection
- Short circuit current limiting
- Output transistor SOA protection
- RoHS Compliance

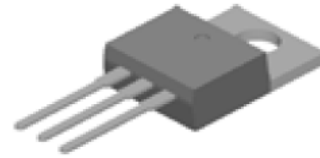

TO-220

Applications

- High Efficiency Linear Regulator
- Post Regulation for Switching Supply
- Microprocessor Power Supply
- Mother Board

Block Diagram

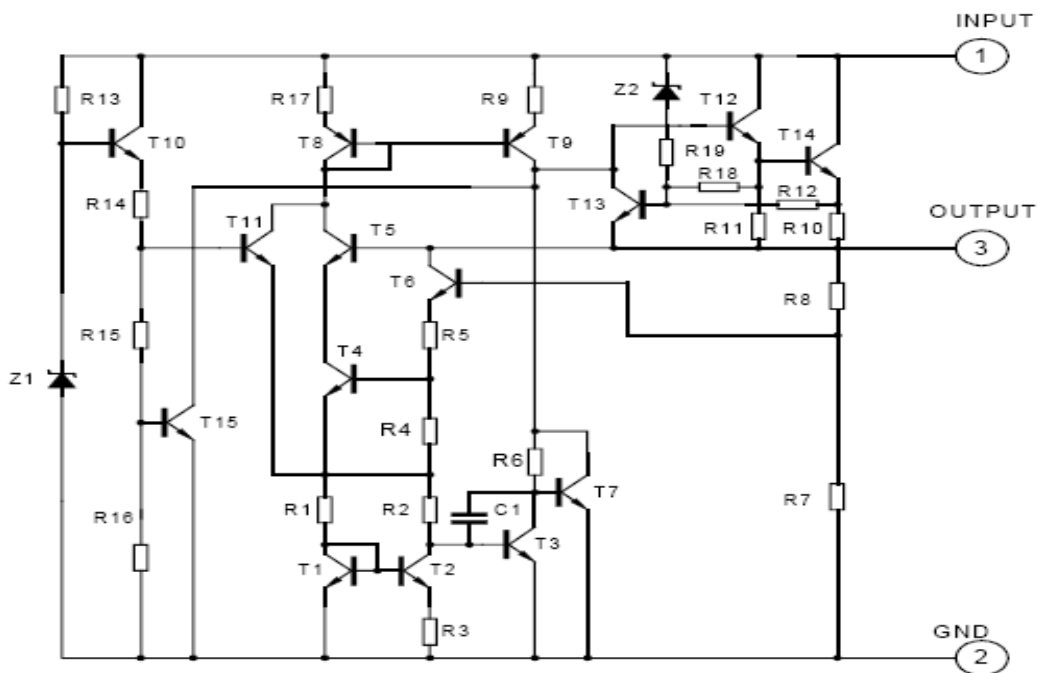

Absolute Maximum Ratings

Symbol	Description		Ratings	Unit
V_{IN}	Input Voltage	$V_{OUT}=3.3\sim 18V$	35	V
		$V_{OUT}=20\sim 24V$	40	
I_{OUT}	Output Current		1	A
P_D	Power Dissipation	TO-220	Internally Limited	mW
T_J	Junction Temperature		150	
T_{OPR}	Operating Temperature Range		-20 ~ 150	° C
T_{STG}	Storage Temperature Range		-55 ~ 150	° C

- Note:** 1. Absolute maximum ratings are stress ratings only and functional device operation is not implied. The device could be damaged beyond Absolute maximum ratings.
2. The maximum steady state usable output current are dependent on input voltage, heat sinking, lead length of the package and copper pattern of PCB. The data are showed as electrical characteristics table represents pulse test conditions with junction temperatures specified at the initiation of test.

Electrical Characteristics ($T_J=25^\circ\text{C}$, $P_D \leq 15W$, unless otherwise specified)

For SL7805 ($V_{IN}=10V$, $I_{OUT}=0.5A$, $C_1=0.33\mu F$, $C_o=0.1\mu F$)

Symbol	Description	SL7805			Unit	Test Conditions
		Min.	Typ.	Max.		
V_{OUT}	Output Voltage	4.80	5.0	5.20	V	$I_{OUT}=5mA-1.0A$
		4.75	-	5.25	V	$7.5V \leq V_{IN} \leq 20V$, $I_{OUT}=5mA-1.0A$
ΔV_{OUT}	Load Regulation	-	-	50	mV	$I_{OUT}=5mA-1.0A$
		-	-	25	mV	$I_{OUT}=0.25A-0.75A$
ΔV_{OUT}	Line Regulation	-	-	50	mV	$7V \leq V_{IN} \leq 25V$
		-	-	50	mV	$7.5V \leq V_{IN} \leq 20V$, $I_{OUT}=1.0A$
I_q	Quiescent Current	-	-	8.0	mA	$I_{OUT} \leq 1.0A$
ΔI_q	Quiescent Current Change	-	-	1.0	mA	$7.5V \leq V_{IN} \leq 20V$
		-	-	0.5	mA	$I_{OUT}=5mA-1.0A$
e_N	Output Noise Voltage	-	40	-	μV	$10Hz \leq f \leq 100KHz$
$\Delta V_o/\Delta T$	Temperature coefficient of V_{OUT}	-	-0.6	-	$mV/^\circ C$	$I_{OUT}=5mA$
RR	Ripple Rejection	62	80	-	dB	$8V \leq V_{IN} \leq 18V$, $f=120Hz$
I_{PEAK}	Peak Output Current	-	1.8	-	A	-
I_{sc}	Short-Circuit Current	-	250	-	mA	$V_{IN}=35V$
V_D	Dropout Voltage	-	2.0	-	V	-

For SL7806 ($V_{IN}=11V$, $I_{OUT}=0.5A$, $C1=0.33\mu F$, $C_o =0.1\mu F$)

Symbol	Description	SL7806			Unit	Test Conditions
		Min.	Typ.	Max.		
V_{OUT}	Output Voltage	5.76	6.0	6.24	V	$I_{OUT}=5mA-1.0A$
		5.70	-	6.30	V	$8.5V \leq V_{IN} \leq 21V$, $I_{OUT}=5mA-1.0A$
ΔV_{OUT}	Load Regulation	-	-	60	mV	$I_{OUT}=5mA-1.0A$
		-	-	30	mV	$I_{OUT}=0.25A-0.75A$
ΔV_{OUT}	Line Regulation	-	-	60	mV	$8V \leq V_{IN} \leq 25V$
		-	-	60	mV	$8.5V \leq V_{IN} \leq 21V$, $I_{OUT}=1.0A$
I_Q	Quiescent Current	-	-	8.0	mA	$I_{OUT} \leq 1.0A$
ΔI_Q	Quiescent Current Change	-	-	1.0	mA	$8.5V \leq V_{IN} \leq 21V$
		-	-	0.5	mA	$I_{OUT}=5mA-1.0A$
e_N	Output Noise Voltage	-	45	-	μV	$10Hz \leq f \leq 100KHz$
ΔV_O/ΔT	Temperature coefficient of V _{OUT}	-	-0.7	-	mV/°C	$I_{OUT}=5mA$
RR	Ripple Rejection	59	75	-	dB	$9V \leq V_{IN} \leq 19V$, $f=120Hz$
I_{PEAK}	Peak Output Current	-	1.8	-	A	-
I_{SC}	Short-Circuit Current	-	250	-	mA	$V_{IN}=35V$
V_D	Dropout Voltage	-	2.0	-	V	-

For SL7808 ($V_{IN}=14V$, $I_{OUT}=0.5A$, $C1=0.33\mu F$, $C_o =0.1\mu F$)

Symbol	Description	SL7808			Unit	Test Conditions
		Min.	Typ.	Max.		
V_{OUT}	Output Voltage	7.68	8.0	8.32	V	$I_{OUT}=5mA-1.0A$
		7.60	-	8.40	V	$10.5V \leq V_{IN} \leq 23V$, $I_{OUT}=5mA-1.0A$
ΔV_{OUT}	Load Regulation	-	-	80	mV	$I_{OUT}=5mA-1.0A$
		-	-	40	mV	$I_{OUT}=0.25A-0.75A$
ΔV_{OUT}	Line Regulation	-	-	80	mV	$10.5V \leq V_{IN} \leq 25V$
		-	-	80	mV	$10.5V \leq V_{IN} \leq 23V$, $I_{OUT}=1.0A$
I_Q	Quiescent Current	-	-	8.0	mA	$I_{OUT} \leq 1.0A$
ΔI_Q	Quiescent Current Change	-	-	1.0	mA	$10.5V \leq V_{IN} \leq 23V$
		-	-	0.5	mA	$I_{OUT}=5mA-1.0A$
e_N	Output Noise Voltage	-	58	-	μV	$10Hz \leq f \leq 100KHz$
ΔV_O/ΔT	Temperature coefficient of V _{OUT}	-	-0.9	-	mV/°C	$I_{OUT}=5mA$
RR	Ripple Rejection	56	72	-	dB	$11.5V \leq V_{IN} \leq 21.5V$, $f=120Hz$
I_{PEAK}	Peak Output Current	-	1.8	-	A	-
I_{SC}	Short-Circuit Current	-	250	-	mA	$V_{IN}=35V$
V_D	Dropout Voltage	-	2.0	-	V	-

For SL7809 ($V_{IN}=15V$, $I_{OUT}=0.5A$, $C1=0.33\mu F$, $C_o =0.1\mu F$)

Symbol	Description	SL7809			Unit	Test Conditions
		Min.	Typ.	Max.		
V_{OUT}	Output Voltage	8.64	9.0	9.36	V	$I_{OUT}=5mA-1.0A$
		8.55	-	9.45	V	$11.5V \leq V_{IN} \leq 24V$, $I_{OUT}=5mA-1.0A$
ΔV_{OUT}	Load Regulation	-	-	90	mV	$I_{OUT}=5mA-1.0A$
		-	-	45	mV	$I_{OUT}=0.25A-0.75A$
ΔV_{OUT}	Line Regulation	-	-	90	mV	$11.5V \leq V_{IN} \leq 25V$
		-	-	90	mV	$11.5V \leq V_{IN} \leq 24V$, $I_{OUT}=1.0A$
I_q	Quiescent Current	-	-	8.0	mA	$I_{OUT} \leq 1.0A$
ΔI_q	Quiescent Current Change	-	-	1.0	mA	$11.5V \leq V_{IN} \leq 24V$
		-	-	0.5	mA	$I_{OUT}=5mA-1.0A$
e_N	Output Noise Voltage	-	58	-	μV	$10Hz \leq f \leq 100KHz$
$\Delta V_o/\Delta T$	Temperature coefficient of V_{OUT}	-	-1.1	-	mV/°C	$I_{OUT}=5mA$
RR	Ripple Rejection	56	72	-	dB	$12.5V \leq V_{IN} \leq 22.5V$, $f=120Hz$
I_{PEAK}	Peak Output Current	-	1.8	-	A	-
I_{sc}	Short-Circuit Current	-	250	-	mA	$V_{IN}=35V$
V_D	Dropout Voltage	-	2.0	-	V	-

For SL7810 ($V_{IN}=16V$, $I_{OUT}=0.5A$, $C1=0.33\mu F$, $C_o =0.1\mu F$)

Symbol	Description	SL7810			Unit	Test Conditions
		Min.	Typ.	Max.		
V_{OUT}	Output Voltage	9.60	10.0	10.40	V	$I_{OUT}=5mA-1.0A$
		9.50	-	10.50	V	$12.5V \leq V_{IN} \leq 25V$, $I_{OUT}=5mA-1.0A$
ΔV_{OUT}	Load Regulation	-	-	100	mV	$I_{OUT}=5mA-1.0A$
		-	-	50	mV	$I_{OUT}=0.25A-0.75A$
ΔV_{OUT}	Line Regulation	-	-	100	mV	$13V \leq V_{IN} \leq 25V$
		-	-	100	mV	$13V \leq V_{IN} \leq 25V$, $I_{OUT}=1.0A$
I_q	Quiescent Current	-	-	8.0	mA	$I_{OUT} \leq 1.0A$
ΔI_q	Quiescent Current Change	-	-	1.0	mA	$12.6V \leq V_{IN} \leq 25V$
		-	-	0.5	mA	$I_{OUT}=5mA-1.0A$
e_N	Output Noise Voltage	-	58	-	μV	$10Hz \leq f \leq 100KHz$
$\Delta V_o/\Delta T$	Temperature coefficient of V_{OUT}	-	-1.1	-	mV/°C	$I_{OUT}=5mA$
RR	Ripple Rejection	56	72	-	dB	$13V \leq V_{IN} \leq 23V$, $f=120Hz$
I_{PEAK}	Peak Output Current	-	1.8	-	A	-
I_{sc}	Short-Circuit Current	-	250	-	mA	$V_{IN}=35V$
V_D	Dropout Voltage	-	2.0	-	V	-

For SL7812 ($V_{IN}=19V$, $I_{OUT}=0.5A$, $C1=0.33\mu F$, $C_o =0.1\mu F$)

Symbol	Description	SL7812			Unit	Test Conditions
		Min.	Typ.	Max.		
V_{OUT}	Output Voltage	11.52	12.0	12.48	V	$I_{OUT}=5mA-1.0A$
		11.40	-	12.60	V	$14.5V \leq V_{IN} \leq 27V$, $I_{OUT}=5mA-1.0A$
ΔV_{OUT}	Load Regulation	-	-	120	mV	$I_{OUT}=5mA-1.0A$
		-	-	60	mV	$I_{OUT}=0.25A-0.75A$
ΔV_{OUT}	Line Regulation	-	-	120	mV	$14.5V \leq V_{IN} \leq 30V$
		-	-	120	mV	$14.6V \leq V_{IN} \leq 27V$, $I_{OUT}=1.0A$
I_q	Quiescent Current	-	-	8.0	mA	$I_{OUT} \leq 1.0A$
ΔI_q	Quiescent Current Change	-	-	1.0	mA	$14.5V \leq V_{IN} \leq 30V$
		-	-	0.5	mA	$I_{OUT}=5mA-1.0A$
e_N	Output Noise Voltage	-	75	-	μV	$10Hz \leq f \leq 100KHz$
$\Delta V_o/\Delta T$	Temperature coefficient of V_{OUT}	-	-1.5	-	mV/°C	$I_{OUT}=5mA$
RR	Ripple Rejection	55	72	-	dB	$15V \leq V_{IN} \leq 25V$, $f=120Hz$
I_{PEAK}	Peak Output Current	-	1.8	-	A	-
I_{SC}	Short-Circuit Current	-	250	-	mA	$V_{IN}=35V$
V_D	Dropout Voltage	-	2.0	-	V	-

For SL7815 ($V_{IN}=23V$, $I_{OUT}=0.5A$, $C1=0.33\mu F$, $C_o =0.1\mu F$)

Symbol	Description	SL7815			Unit	Test Conditions
		Min.	Typ.	Max.		
V_{OUT}	Output Voltage	14.40	15.0	15.60	V	$I_{OUT}=5mA-1.0A$
		14.25	-	15.75	V	$17.5V \leq V_{IN} \leq 30V$, $I_{OUT}=5mA-1.0A$
ΔV_{OUT}	Load Regulation	-	-	150	mV	$I_{OUT}=5mA-1.0A$
		-	-	75	mV	$I_{OUT}=0.25A-0.75A$
ΔV_{OUT}	Line Regulation	-	-	150	mV	$18.5V \leq V_{IN} \leq 30V$
		-	-	150	mV	$17.7V \leq V_{IN} \leq 30V$, $I_{OUT}=1.0A$
I_q	Quiescent Current	-	-	8.0	mA	$I_{OUT} \leq 1.0A$
ΔI_q	Quiescent Current Change	-	-	1.0	mA	$17.5V \leq V_{IN} \leq 30V$
		-	-	0.5	mA	$I_{OUT}=5mA-1.0A$
e_N	Output Noise Voltage	-	90	-	μV	$10Hz \leq f \leq 100KHz$
$\Delta V_o/\Delta T$	Temperature coefficient of V_{OUT}	-	-1.8	-	mV/°C	$I_{OUT}=5mA$
RR	Ripple Rejection	54	70	-	dB	$18.5V \leq V_{IN} \leq 28.5V$, $f=120Hz$
I_{PEAK}	Peak Output Current	-	1.8	-	A	-
I_{SC}	Short-Circuit Current	-	250	-	mA	$V_{IN}=35V$
V_D	Dropout Voltage	-	2.0	-	V	-

For SL7818 ($V_{IN}=27V$, $I_{OUT}=0.5A$, $C1=0.33\mu F$, $C_o =0.1\mu F$)

Symbol	Description	SL7818			Unit	Test Conditions
		Min.	Typ.	Max.		
V_{OUT}	Output Voltage	17.28	18.0	18.72	V	$I_{OUT}=5mA-1.0A$
		17.10	-	18.90	V	$21V \leq V_{IN} \leq 33V$, $I_{OUT}=5mA-1.0A$
ΔV_{OUT}	Load Regulation	-	-	180	mV	$I_{OUT}=5mA-1.0A$
		-	-	90	mV	$I_{OUT}=0.25A-0.75A$
ΔV_{OUT}	Line Regulation	-	-	180	mV	$21V \leq V_{IN} \leq 33V$
		-	-	180	mV	$21V \leq V_{IN} \leq 33V$, $I_{OUT}=1.0A$
I_Q	Quiescent Current	-	-	8.0	mA	$I_{OUT} \leq 1.0A$
ΔI_Q	Quiescent Current Change	-	-	1.0	mA	$21.5V \leq V_{IN} \leq 33V$
		-	-	0.5	mA	$I_{OUT}=5mA-1.0A$
e_N	Output Noise Voltage	-	110	-	μV	$10Hz \leq f \leq 100KHz$
$\Delta V_o/\Delta T$	Temperature coefficient of V_{OUT}	-	-2.2	-	mV/°C	$I_{OUT}=5mA$
RR	Ripple Rejection	53	69	-	dB	$22V \leq V_{IN} \leq 32V$, $f=120Hz$
I_{PEAK}	Peak Output Current	-	1.8	-	A	-
I_{sc}	Short-Circuit Current	-	250	-	mA	$V_{IN}=35V$
V_D	Dropout Voltage	-	2.0	-	V	-

For SL7824 ($V_{IN}=33V$, $I_{OUT}=0.5A$, $C1=0.33\mu F$, $C_o =0.1\mu F$)

Symbol	Description	SL7824			Unit	Test Conditions
		Min.	Typ.	Max.		
V_{OUT}	Output Voltage	23.04	24.0	24.96	V	$I_{OUT}=5mA-1.0A$
		22.80	-	25.20	V	$27V \leq V_{IN} \leq 38V$, $I_{OUT}=5mA-1.0A$
ΔV_{OUT}	Load Regulation	-	-	240	mV	$I_{OUT}=5mA-1.0A$
		-	-	120	mV	$I_{OUT}=0.25A-0.75A$
ΔV_{OUT}	Line Regulation	-	-	240	mV	$27V \leq V_{IN} \leq 38V$
		-	-	240	mV	$27V \leq V_{IN} \leq 38V$, $I_{OUT}=1.0A$
I_Q	Quiescent Current	-	-	8.0	mA	$I_{OUT} \leq 1.0A$
ΔI_Q	Quiescent Current Change	-	-	1.0	mA	$28V \leq V_{IN} \leq 38V$
		-	-	0.5	mA	$I_{OUT}=5mA-1.0A$
e_N	Output Noise Voltage	-	170	-	μV	$10Hz \leq f \leq 100KHz$
$\Delta V_o/\Delta T$	Temperature coefficient of V_{OUT}	-	-2.8	-	mV/°C	$I_{OUT}=5mA$
RR	Ripple Rejection	50	66	-	dB	$28V \leq V_{IN} \leq 38V$, $f=120Hz$
I_{PEAK}	Peak Output Current	-	1.8	-	A	-
I_{sc}	Short-Circuit Current	-	250	-	mA	$V_{IN}=35V$
V_D	Dropout Voltage	-	2.0	-	V	-

Typical Characteristics Curves

Fig.1- Peak Output Current vs. Input/Output Differential Voltage

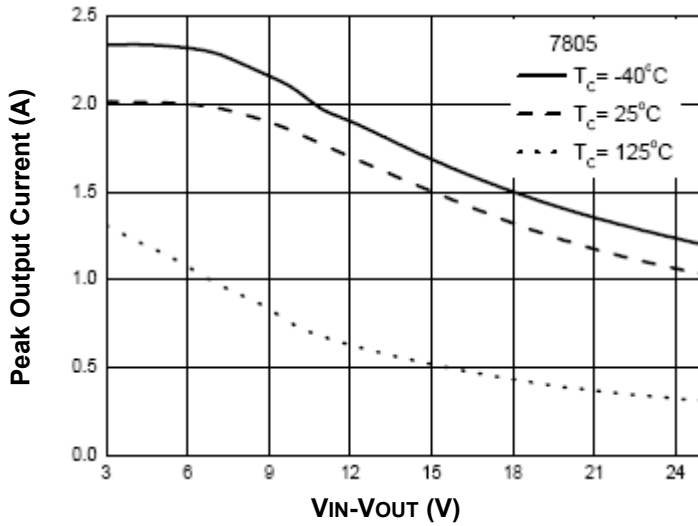

Fig.2- Output Voltage vs. Junction Temperature

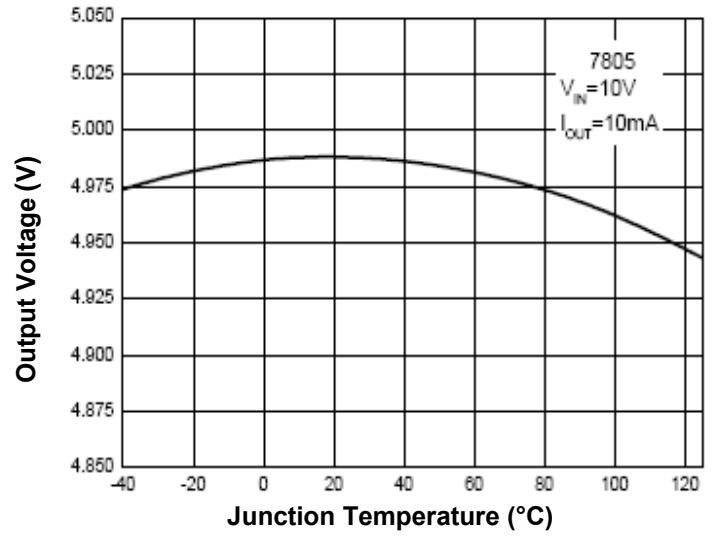

Fig.3- Quiescent Current vs. Junction Temperature

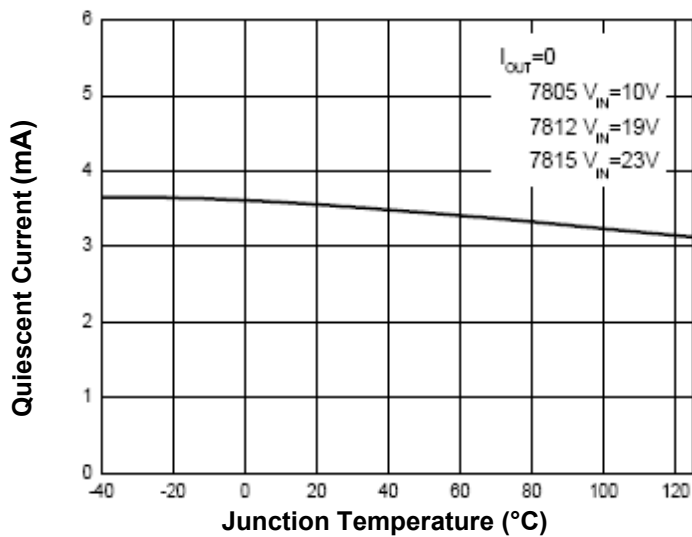
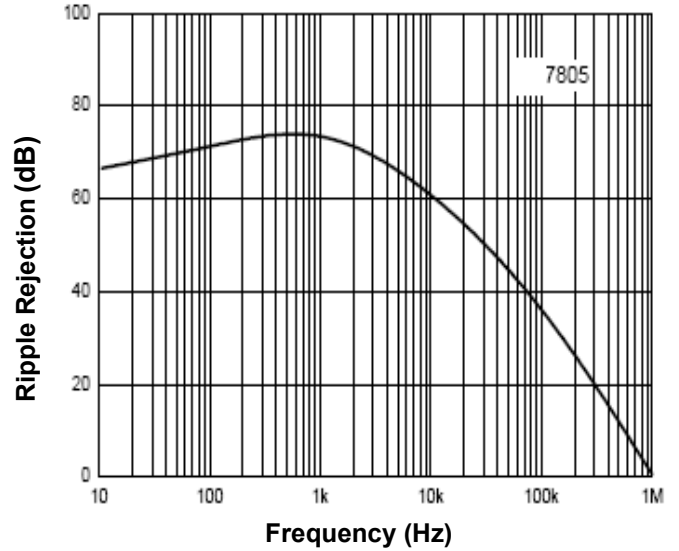

Fig.4- Ripple Rejection vs. Frequency



Typical Characteristics Curves (Continued)

Fig.5- Dropout Voltage vs. Junction Temperature

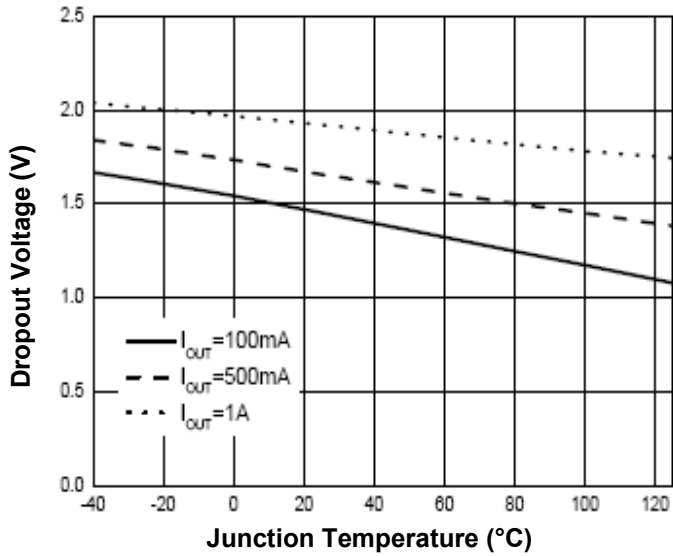

Fig.6- Power Dissipation vs. Case Temperature

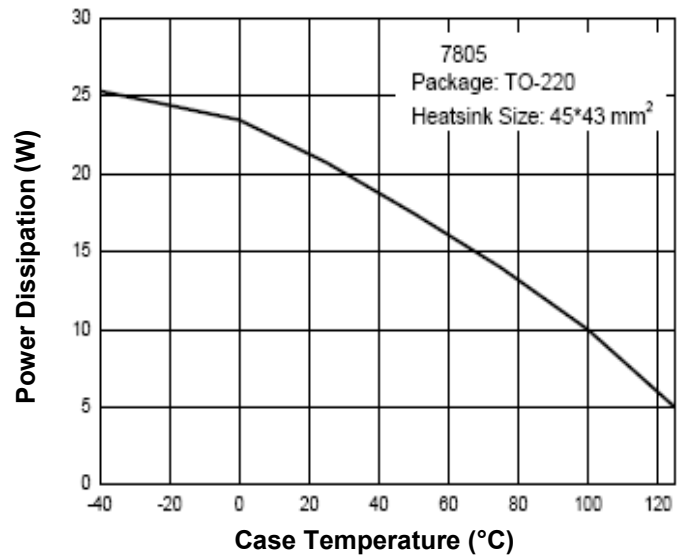

Fig.7- Thermal Shutdown Protection

