

3Quadrants/4 Quadrants TRIAC

Features

- IT(RMS): 16A
- VGT: 1.5V
- VDRM VRRM: 600V and 800V

Applications

Washing machine, vacuums, massager, solid state relay, AC Motor speed regulation and so on.

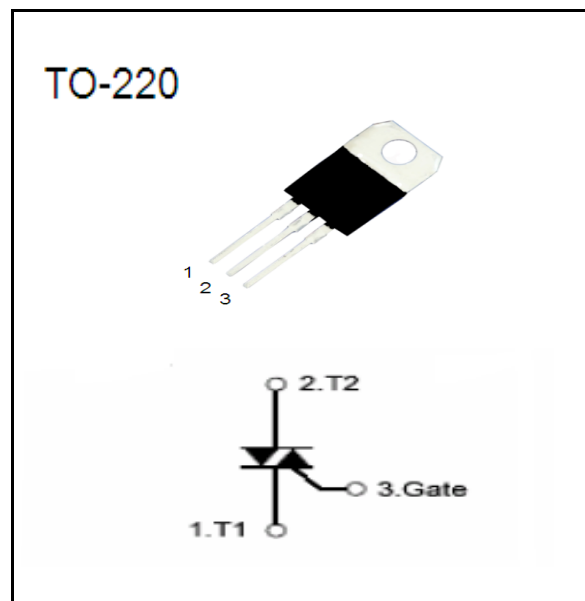

Absolute Maximum Ratings(Tc=25°C unless otherwise specified)

Symbol	parameter	Conditions	Ratings	Unit
VDRM VRRM	Repetitive Peak Off-State Voltage	BTA16 -600	600	V
		BTA16 -800	800	V
IT(RMS)	R.M.S On-State Current	Tc=110°C	16	A
ITSM	Surge On-State Current	f=50/60Hz tp=16.7ms/20ms	160/168	A
I ² t	I ² t for fusing	Tp=10ms	144	A ² s
PG(AV)	Average Gate Power Dissipation	Tj=125°C	1	W
IGM	Peak Gate Current	Tj=125°C	4	A
Tj	Operating Junction Temperature		-40~125	°C
TSTG	Storage Temperature		-40~150	°C

Electrical Characteristics($T_c=25^\circ\text{C}$ unless otherwise specified)

symbol	parameter	Test Conditions	Value					Unit
			SW	CW	BW	C	B	
IDRM	Repetitive Peak Off-State Current	$T_c=25^\circ\text{C}$	≤ 5					μA
		$T_c=125^\circ\text{C}$	≤ 1					mA
IRRM	Repetitive Peak Reverse Current	$T_c=25^\circ\text{C}$	≤ 5					μA
		$T_c=125^\circ\text{C}$	≤ 1					mA
V _{TM}	Forward "on" voltage	$I_T=23\text{A}$, $t_p=380\mu\text{s}$	1.5					V
V _{GT}	Gate trigger voltage	$V_D=12\text{V}$, $R_L=30\Omega$	≤ 1.5					V
di/dt	Critical rate of rise of on-state current	I,II,III	$F=100\text{Hz}$, $I_G=2 \times I_{GT}$, $t_r \leq 100\text{ns}$					$\text{A}/\mu\text{s}$
		IV	≥ 10					$\text{A}/\mu\text{s}$
I _{GT}	Gate trigger current	I,II,III	≤ 10	≤ 25	≤ 50	≤ 25	≤ 50	mA
		IV	/	/	/	≤ 50	≤ 100	mA
I _H	Holding current	$I_T=0.2\text{A}$	≤ 25	≤ 35	≤ 50	≤ 25	≤ 50	mA
V _{GD}	Gate non-trigger voltage	$V_D=V_{DRM}$, $T_J=125^\circ\text{C}$, $R_L=3.3\text{K}\Omega$	≥ 0.2					V
dv/dt	Critical-rate of rise of commutation voltage	$T_J=125^\circ\text{C}$, $V_D=2/3V_{DRM}$, Gate open circuit	≥ 100	≥ 400	≥ 1000	≥ 200	≥ 400	$\text{V}/\mu\text{s}$
R _{th(j-c)}	Thermal resistance	Junction to case	2.1					$^\circ\text{C}/\text{W}$
R _{th(j-a)}	Thermal resistance	Junction to ambient	60					$^\circ\text{C}/\text{W}$

characteristic curve

FIG.1:Gate characteristics

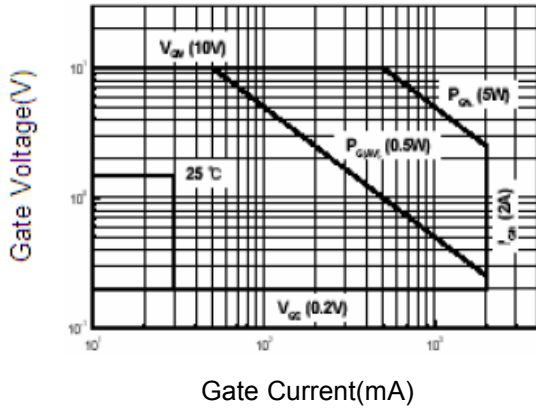

FIG.2: On-state characteristics(max)

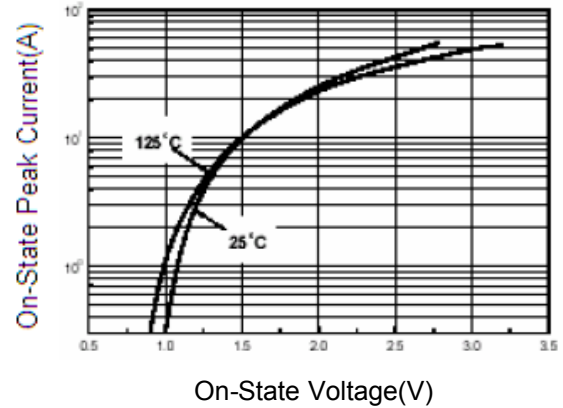

FIG.3:Gate trigger voltage vs junction temperature

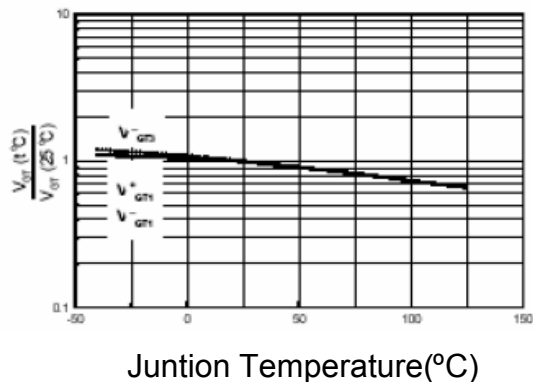

FIG.4:on-state current vs max power Dissipation

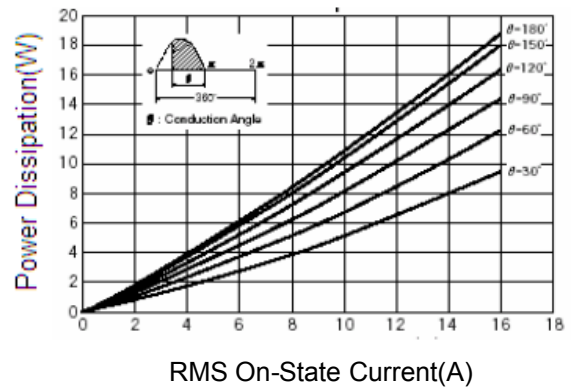

FIG.5:RMS On-state vs Allowable Case Temperature

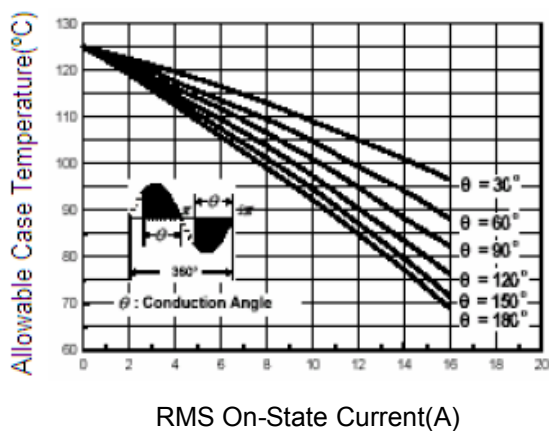
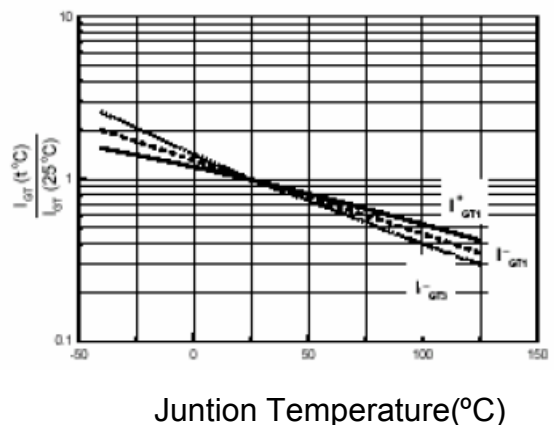
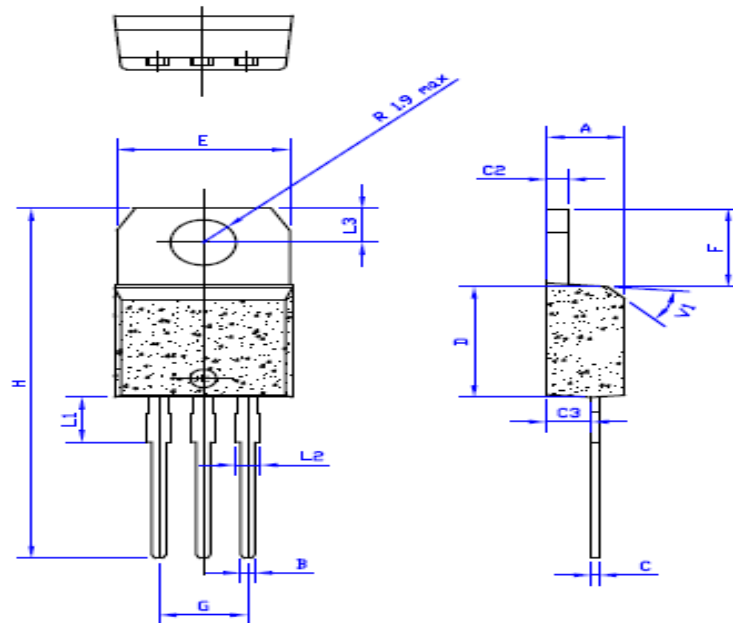

FIG.6:Gate trigger current vs junction temperature



PACKAGE MECHANICAL DATA

TO-220 Package Dimension



Ref.	Dimensions					
	Millimeters			Inches		
	Min.	Typ.	Max.	Min.	Typ.	Max.
A	4.4		4.6	0.173		1.181
B	0.61		0.88	0.024		0.034
C	0.46		0.70	0.018		0.027
C2	1.23		1.32	0.048		0.051
C3	2.4		2.72	0.094		0.107
D	8.6		9.7	0.338		0.382
E	9.8		10.4	0.386		0.409
F	6.2		6.6	0.244		0.259
G	4.8		5.4	0.189		0.213
H	28.0		29.8	11.0		11.7
L1		3.75			0.147	
L2	1.14		1.7	0.044		0.066
L3	2.65		2.95	0.104		0.116
V1		40°			40°	